





TECHNOALPIN®
snow experts

MTS
MANUAL TOWER SNOWGUN

www.technoalpin.com

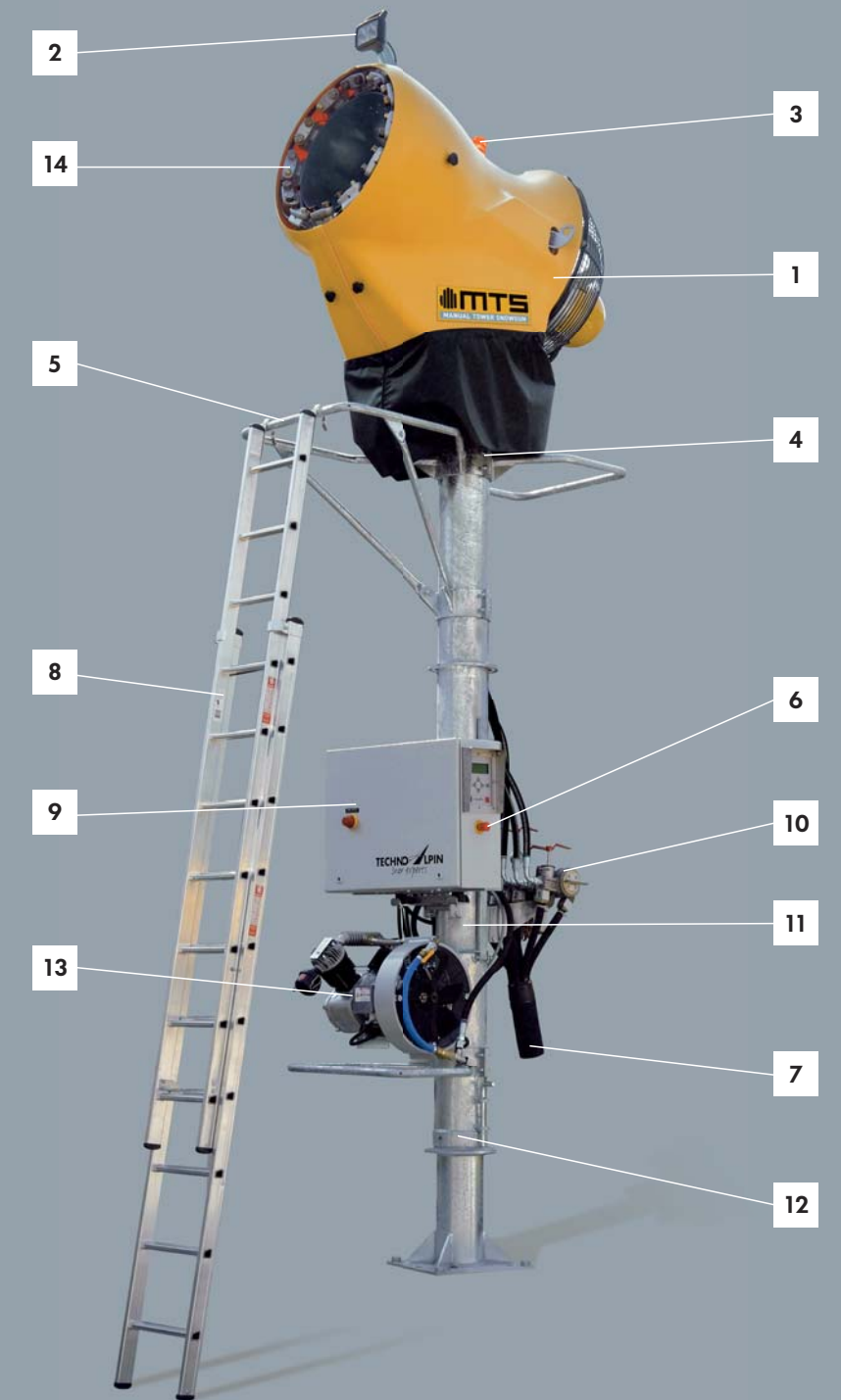
TECHNOALPIN®
snow experts



	
1 Turbine	Turbine
2 Arbeitsscheinwerfer	Working headlight
3 Rundumleuchte	Indicator
4 Manuelle Höhenverstellung	Height adjustment
5 Einhängbügel für Leiter	Hooking support for service ladder
6 NOT-AUS Taster	Emergency stop button
7 Entleerung, beheizt	Discharge collector, heated
8 Leiter mit Sicherheitshaken (Optional)	Ladder with safety hooks (optional)
9 Schaltschrank	Electrical cabinet
10 Ventilblock, manuell	Manual valve block
11 Hebel für Schwenkung	Rotation Lever
12 Blockierung Rotation	Tilt stopper
13 Kompressor	Compressor
14 Düsenkranz	Nozzles ring

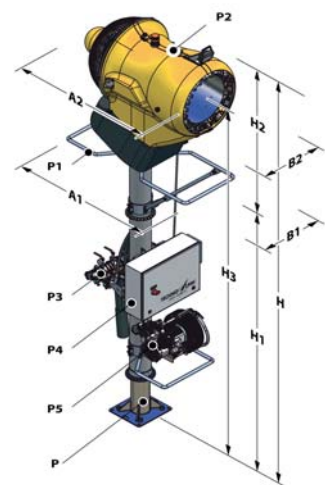

Abmessungen Schneeerzeuger

Länge A2	1700 mm / 66.9 in
Breite B2	980 mm / 38.6 in
Höhe H2	1500 mm / 59.0 in



Dimensional data gun

Length A2	1700 mm / 66.9 in
Width B2	980 mm / 38.6 in
Height H2	1500 mm / 59.0 in

Abmessungen Unterbau

Länge A1	1700 mm / 66.9 in
Breite B1	720 mm / 28.3 in
Höhe H1	3300 mm / 129.9 in

Dimensional data support

Length A1	1700 mm / 66.9 in
Width B1	720 mm / 28.3 in
Height H1	3300 mm / 129.9 in

Abmessungen

Gesamthöhe H	5000 mm / 196.5 in
Fallhöhe Schnee H3	4400 mm / 173.2 in

Dimensional data

Total height H	5000 mm / 196.5 in
Snowfall height H3	4400 mm / 173.2 in

Gewicht

MTS gesamt	Complete MTS	700 kg / 1543.3 lb
Unterbau P1	Support P1	35 kg / 77.12 lb
Turbine P2	Gun P2	320 kg / 705.5 lb
Ventilblock P3	Valve block P3	25 kg / 55.2 lb
Schaltschrank P4	Control cabinet P4	100 kg / 220.5 lb
Kompressor P5	Compressor P5	80 kg / 176.4 lb
Turm P	Tower P	170 kg / 374.79 lb

Weight

Elektrische Daten

Nennspannung	Rated voltage	400 / 480 / 600 V*
Stromaufnahme bei Vollast	Full load current	40 / 35 / 30 A*
Nennfrequenz	Nominal frequency	50 / 60 Hz*
Lüfterleistung	Largest motor	12.5 kW / 17 HP
Kompressorleistung	Compressor	4 kW / 5.44 HP
Heizung	Heating	0.5 - 1.7 kW
Anschlussstecker	Fuse	63 A* (type 1)

Electrical data

Allgemeine technische Daten

Schwenkwinkel	Swinging angle	360°
Turbineneigung	Turbine inclination angle	40°
Anschluss (Typ Camlock)	Camlock connection	2 in
Betriebswasserdruck	Operating water pressure	8 - 40 bar / 116 - 580 psi
Wasserdruck max.	Pressure max.	50 bar / 725,2 psi
Betriebstemperatur	Operating air temperature	-25 - +2°C / -13 - +35,6°F
Wasserfilter	Water filter	250 micron
Nukleatoren	Nucleators no.	6
Fixe Düsen Quadrijet	Fixed nozzles type Quadrijet no.	6
Größe - fixe Düsen Quadrijet	Fixed nozzles type Quadrijet size	5 l/min at 4 bar 1.32 gpm at 58 psi
Zuschaltbare Düsen Quadrijet	Controllable nozzles type Quadrijet no.	12
Größe - zuschaltbare Düsen Quadrijet	Controllable nozzles type Quadrijet size	10 l/min at 4 bar 2.64 gpm at 58 psi
Steuerung - SPS	Control unit - PLC no.	1

Miscellaneous tech. specifications

(*): Änderungen je nach Art der Anlage und/oder Art der Installation vorbehalten (beziehen Sie sich auf die Elektroschaltpläne)

04.2011 - Technische Änderungen vorbehalten

(*): Subject to changes based on the type of plant and/or on the installation type (refer to the wiring diagrams)

04.2011 - Technical specifications subject to change

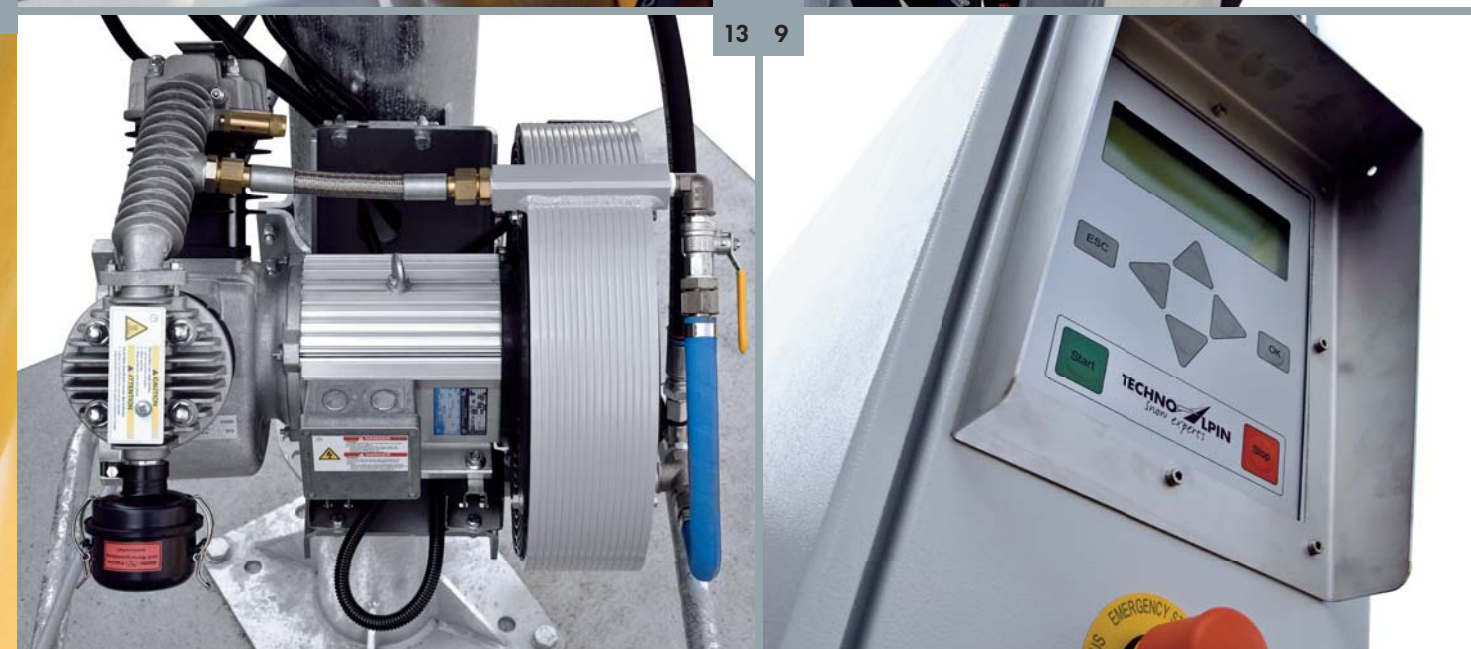
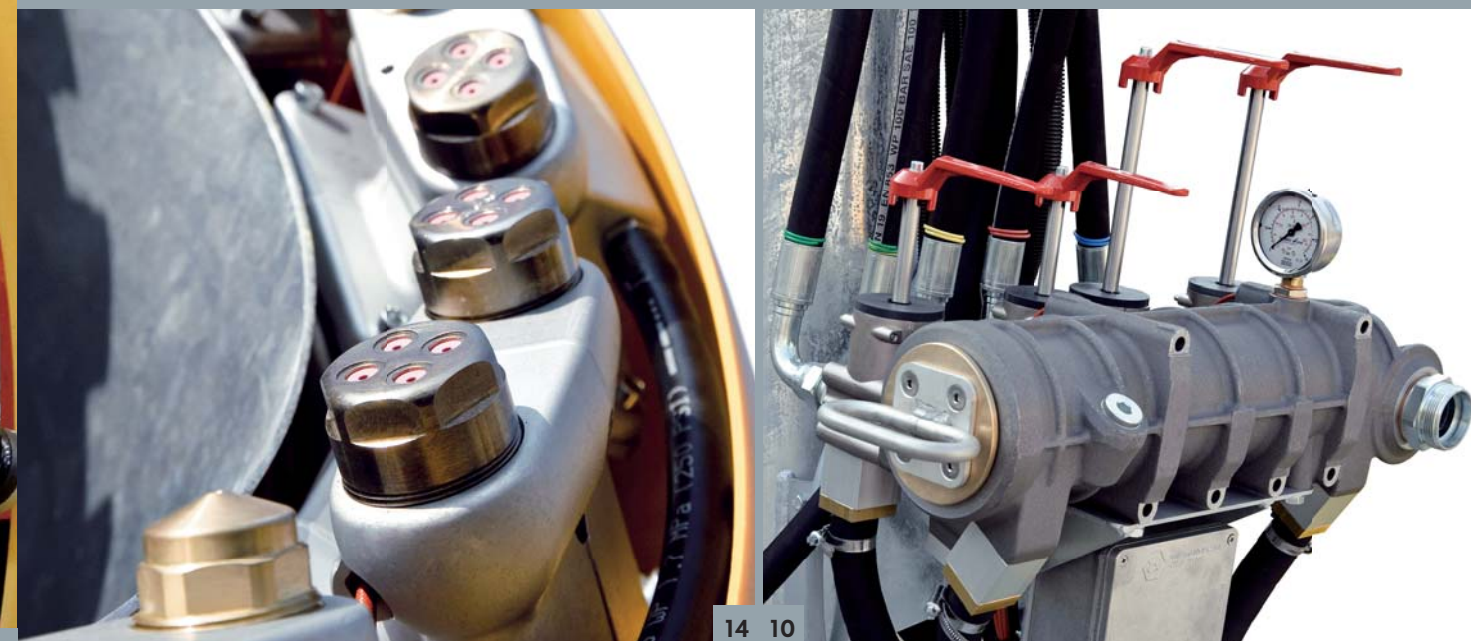
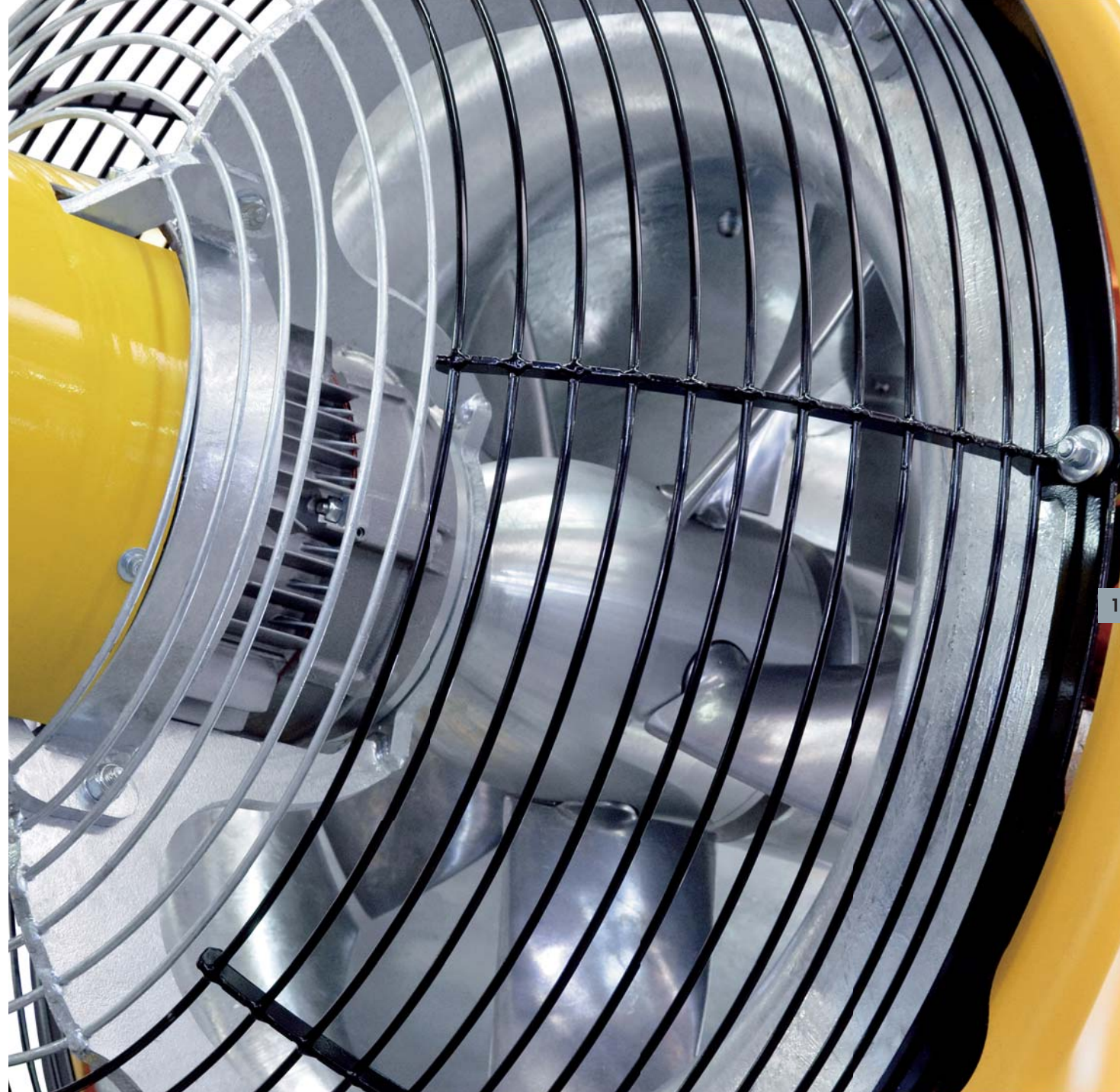

TECHNISCHE DATEN / TECHNICAL DATA

Manueller Schneeerzeuger ausgeführt als Niederdruck-Propellermaschine **auf Fixturm mit 3,3 m Höhe**. Bestehend aus Turbineneinheit mit Ventilatormotor, feuerverzinktem Stahllüfter und neuartiger, tiefgezogener Verkleidung aus PE. Der ölfreie 4 kW Kompressor, der Steuerschaltschrank und der manuell zu schaltende Ventilblock mit Filtereinsatz in Chromnickelstahl befinden sich servicefreundlich im unteren Bereich der Turmsäule um vom Boden aus zugänglich zu sein. Die Maschine ist mit manueller Schwenkung und Höhenverstellung ausgestattet.

Manual snow gun designed as a low-pressure fan gun and mounted **on a fixed tower at a height of 3.3 m**. Comprising turbine unit with fan motor, galvanized steel fan and new-look moulded PE cover. The oil-free 4 kW compressor, electric control cabinet and manually operated valve block with nickel chromium steel filter insert are located near the base of the tower for convenient access from the ground for ease of servicing. The machine can be manually pivoted and has a height adjustment facility.